



Inogen, Inc.

859 Ward Drive, Suite 200 Goleta, CA 93111, USA
E-mail: info@inogen.net www.inogen.com



Suzhou Yuyue Medical Technology Co., Ltd.

No.9 Jinfeng Road., Suzhou Science &
Technology Town, 215163 Suzhou, Jiangsu, PRC
Tel: +86-512-67373001
web address: www.yuwell.com

User Manual

Aurora Full Face Mask

F1

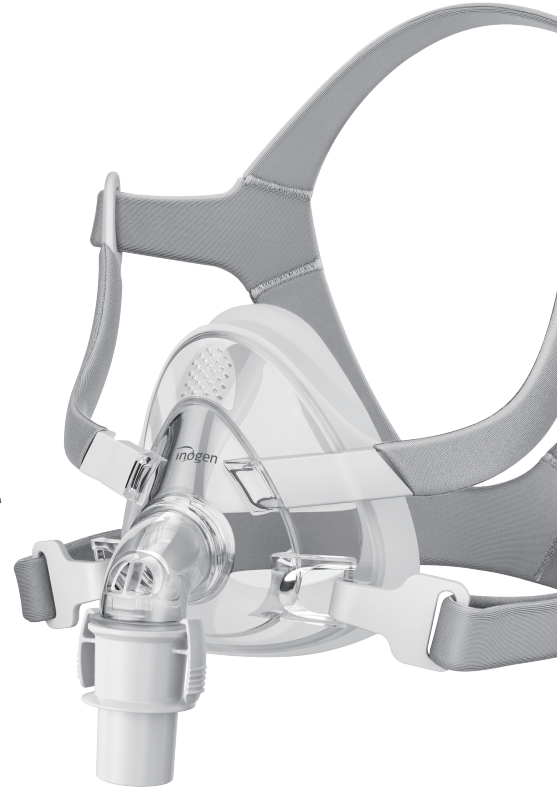

Intended use

The mask is a noninvasive accessory used for channeling airflow (With or without supplemental oxygen) to a patient from a positive airway pressure (PAP) device such as a continuous positive airway pressure (CPAP) or bi-level system.

- The mask is to be used by patients (weighing > 30kg), intended for single-patient reuse in the home environment.
- The mask is intended for single-patient use in the hospital or institutional environment.

Contraindications

If the user has the following diseases, the product may not be suitable for use. Special attention should also be given when it must be used. In either case, it is up to the doctor to decide whether or not to use the mask. These diseases include:

- Recent eye surgery or dry eyes
- Glaucoma
- Hiatal hernia
- Impaired cardiac sphincter function, excessive reflux, impaired cough reflex
- Vomiting
- Bullous Lung Disease
- Pathologically Low Blood Pressure
- Bypassed Upper Airway
- Pneumothorax
- Diagnosed with acute sinusitis or otitis media
- At risk for aspiration of gastric contents
- Allergy or hypersensitivity to the mask materials, or on patients unable to remove the mask

CAUTION

In the US, Federal law restricts the sale of this device to sale by or on the order of a physician.

WARNINGS

- Please read the entire guide before use.
- The vent holes must be kept clear.

- Explanation of Warning: CPAP systems are intended to be used with special masks with connectors which have vent holes to allow continuous flow of air out of the mask. When the CPAP machine is turned on and functioning properly, new air from the CPAP machine flushes the exhaled air out through the attached mask exhalation port. However, when the CPAP machine is not operating, enough fresh air will not be provided through the mask, and exhaled air will be rebreathed. Rebreathing of exhaled air for longer than several minutes can, in some circumstances, lead to suffocation. This warning applies to most models of CPAP systems.
- At low CPAP pressures the flow through the exhaled port may be inadequate to clear all exhaled gas from the tube. Some rebreathing may occur.
- To minimize the risk of vomiting during sleep, the patient should avoid eating or drinking for three hours before using the mask. This mask is not recommended if the patient is taking a prescription drug that may cause vomiting.
- Do not use the mask without the Non-Rebreathing Valve in place.
- This mask should not be used on patients who are uncooperative, obtunded, unresponsive, or unable to remove the mask.
- Follow all precautions when using supplemental oxygen.
- Oxygen flow must be turned off when the flow generator is not operating, so that unused oxygen does not accumulate within the flow generator enclosure and create a risk of fire.
- At a fixed flow rate of supplemental oxygen flow, the inhaled oxygen concentration varies, depending on the pressure settings, patient breathing pattern, mask, point of application and leak rate.
- The technical specifications of the mask are provided for your clinician to check if it is compatible with the flow generator. If it is used beyond technical specifications or used with incompatible devices, the seal and comfort of the mask may not be effective, optimum therapy may not be achieved, and leak, or variation in the rate of leak, may affect the function of the flow generator.
- Stop using the mask and consult your physician or sleep therapist, if you have ANY adverse reaction to the use of the mask.

- Refer to your flow generator manual for details on settings and operational information.
- As with all masks, some rebreathing may occur at low CPAP pressures.
- Remove all packaging before using the mask.

Parts of the mask

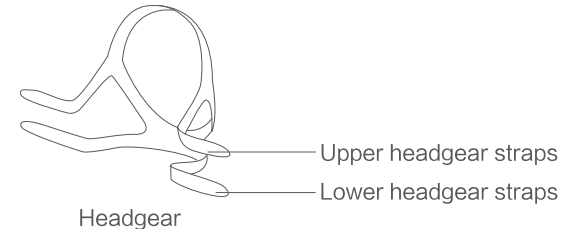
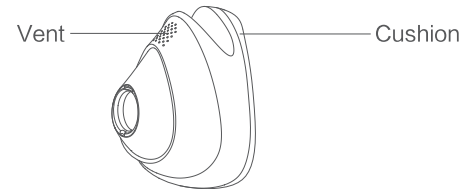
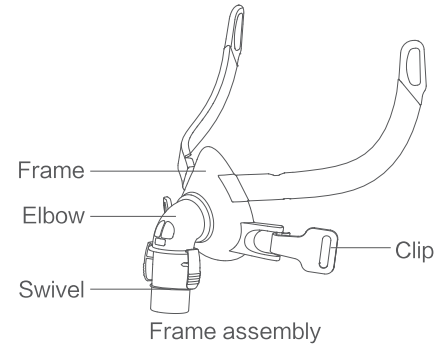

Fitting

Use a standard conical connector if pressure readings and / or supplemental oxygen are required.

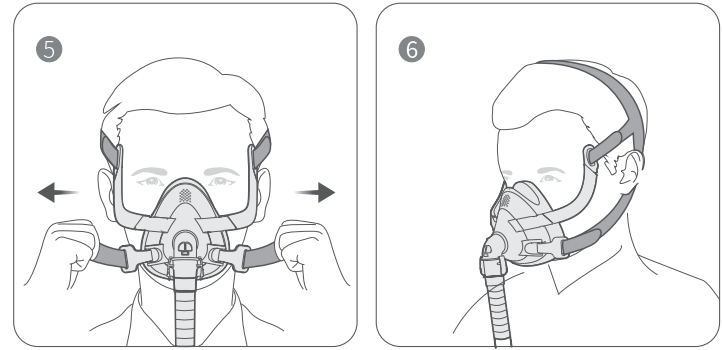
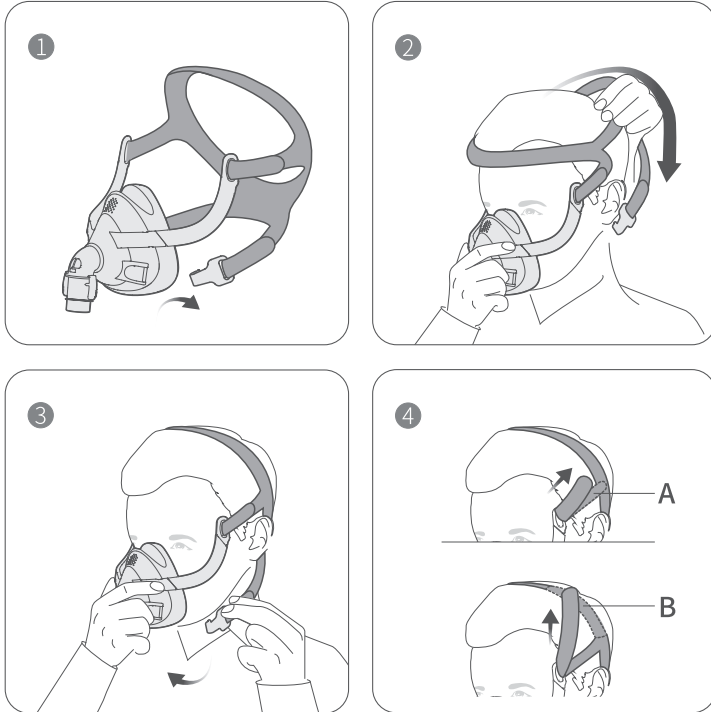

1. Unclip one of the lower headgear clips from the frame.
2. Hold the mask steady on your face and pull the headgear over your head.
3. Bringing the lower headgear straps below your ears, clip the headgear to the lower part of the frame.
4. Undo the fastening tabs on the upper headgear straps. Pull the straps evenly towards the top of head or above ears until the mask is stable and comfortable. Reattach the fastening tabs.
5. Undo the fastening tabs on the lower headgear straps. Pull the straps evenly until the mask is stable and comfortable. Reattach the fastening tabs.
6. Your mask and headgear should be positioned as shown in the illustration.

⚠ Note:

Connect the device air tubing to the swivel of mask and ensure it is firmly connected.

Removal

To remove the mask, disconnect one of the lower headgear clips and pull the mask and headgear up over your head.

⚠ CAUTIONS

- Do not remove the headgear until the clips is released
- Please confirm that you can remove the buckle and headgear freely

Disassembly

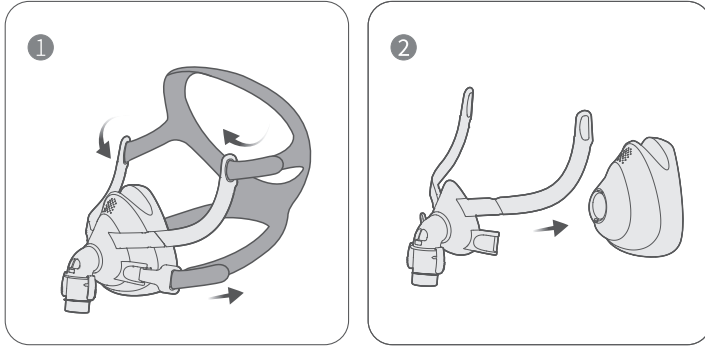

1. Undo the fastening tabs on the upper headgear straps. Unclip the lower headgear clips and unhook the upper headgear Straps.
2. Gently separate the cushion from the frame.

Reassembly

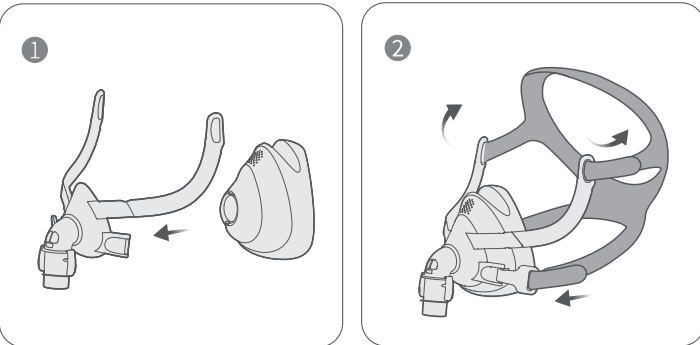

1. Fit the cushion into the channel of the frame.
2. Thread the upper headgear straps through the loop of the frame. Keep the clips attached to the lower headgear straps and clip the headgear to the lower part of the frame.

Cleaning the Mask at Home

⚠ Notes:

- The mask and headgear can only be cleaned through hand washing.
- The elbow and the valve cannot be disassembled for washing.
- If any visible deterioration of a mask component is apparent (cracking, crazing, tears etc), the mask component should be discarded and replaced.
- Recommend replacing mask after 30 cleanings (approximately once a month).

⚠ CAUTIONS

- Do not use solutions containing bleach, chlorine, alcohol, aromatics, moisturizers, antibacterial agents, or scented oils to clean any part of the system or air tubing. These solutions may cause damage and reduce the life of the product.
- Exposing any part of the system or tubing to direct sunlight or heat may cause deterioration.
- Do not use dishwasher to wash this mask.
- Do not air dry in the direct sunlight as it may accelerate product aging.
- Do not iron the headgear. It may damage the headgear.
- If cleaning is not done in accordance with the instructions, may result in poor product performance or reduced product life.

Daily / After Each Use

- Disassemble the mask components according to the disassembly instructions.
- Thoroughly clean the separated mask components (excluding headgear), by gently rubbing in warm (approx. 30° C) water using mild soap. Soak in water no more than 10 minutes.

- Use a soft bristle brush to clean the vent.
- To optimise the mask seal, facial oils should be removed from the cushion after use.
- Inspect each component and, if required, repeat washing until visually clean, making sure there is no soap residue.
- Rinse all components well 3–5min with drinking quality water and allow to air dry out of direct sunlight.
- When all components are dry, reassemble according to the reassembly instructions.

Weekly

- Hand wash the headgear and all components in warm (approx. 30°C) and soapy water. Use pure soap. Rinse the components well and allow them to air dry out of direct sunlight.
- If any visible deterioration of a mask component is apparent (cracking, crazing, tears etc), the mask component should be discarded and replaced.

Use the Mask in the Hospital or Institutional environment

⚠ CAUTIONS

The mask is for single-patient use in the hospital or institutional environment. Cleaning methods according to section: Cleaning the Mask at Home.

Troubleshooting

Problem	Possible cause	Solution
Mask is too noisy	Vents are blocked or partially blocked. Mask is assembled incorrectly.	Clean vents according to Instructions in “Cleaning the Mask at Home” . Reassemble mask.
Mask leaks around the face.	Mask may have been fitted incorrectly.	Carefully follow instructions in “Fitting” .

Mask is uncomfortable

Mask may have been fitted incorrectly.

Carefully follow instructions in “Fitting” .

Mask cushion may be dirty.

Clean vents according to Instructions in “Cleaning the Mask at Home” .

Technical Specifications

Pressure–Flow Curve

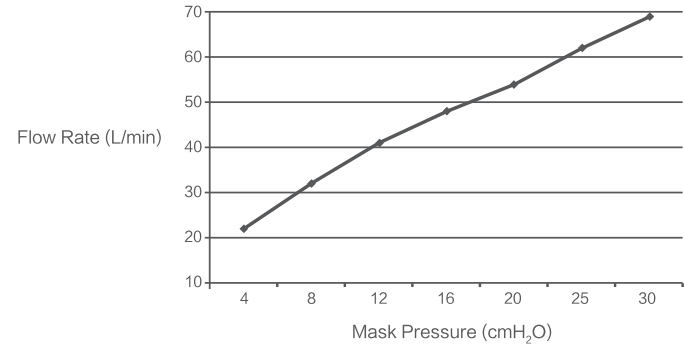

Dead Space Information

Dead space is the empty volume of the mask up to the swivel.
The dead space of the mask varies according to cushion sizes but is less than 208 mL.

Therapy Pressure

4 to 30 cmH₂O

Resistance	Drop in Pressure measured at 50 L/min: $\leq 0.5 \text{ cmH}_2\text{O}$ at 100 L/min: $\leq 1.5 \text{ cmH}_2\text{O}$
Inspiratory and expiratory resistance with the Non-Rebreathing Valve open-to-atmosphere pressure	Inspiratory at 50 L/min: $\leq 2 \text{ cmH}_2\text{O}$ Expiratory at 50 L/min: $\leq 2 \text{ cmH}_2\text{O}$
The Non-Rebreathing Valve open-to-atmosphere pressure	$\leq 2 \text{ cmH}_2\text{O}$
The Non-Rebreathing Valve closed-to-atmosphere pressure	$\leq 2 \text{ cmH}_2\text{O}$
Sound	DECLARED DUAL-NUMBER NOISE EMISSION VALUES in accordance with ISO 4871. The A-weighted sound power level of the mask is less than 33 dBA, with uncertainty 3 dBA. The A-weighted sound pressure level of the mask at a distance of 1 m is less than 25 dBA, with uncertainty 3 dBA.
Environmental Conditions	Operating temperature: $+5^\circ\text{C}$ to $+40^\circ\text{C}$ (41°F to 104°F) Operating humidity: 10% ~ 90% relative humidity non-condensing Storage and transport: -20°C to $+60^\circ\text{C}$ (-4°F to 140°F) Storage and transport humidity: 10% ~ 90% relative humidity non-condensing

Note: The mask system does not contain natural rubber latex, PVC or DEHP materials.

Storage

Ensure that the mask is thoroughly clean and dry before storing it for any length of time. Store the mask in a dry place out of direct sunlight.

Disposal

The mask does not contain any hazardous substances and may be disposed of with your normal household refuse.

Symbols

System and Packaging



Batch code



Date of manufacture



Catalog number



Not made with natural rubber latex



Temperature limitation



Humidity limitation



Manufacturer



Unique device identifier



Medical Device



Use-by date



Consult instructions for use



Single Patient – multiple use



Caution, consult accompanying documents.

Indicates a Warning or Caution and alerts you to a possible injury or explains special measures for the safe and effective use of the device.



Keep away from sunlight

This warranty does not exclude or limit the application of any provision of any law where to do so would contravene that law or cause any part of this warranty to be void.

Limited Warranty

Inogen warrants that Inogen masks, when used in accordance with the instructions for use, shall be free from defects in workmanship and materials and will perform in accordance with the published product specifications for a period of 90 days from the date of purchase by the end user and is non-transferable.

This warranty does not cover damage caused by:

- Accident;
- Misuse or abuse;
- Modification;
- Failure to follow the instructions for use;
- Unsuitable physical or operating environment;
- Failure caused by a product not supplied or manufactured by Inogen; or
- Failure to use original spare parts.

Warranty claims can only be made when accompanied by proof of purchase (e.g., sales receipt). For claims that fall under the scope of this warranty, Inogen will replace the product or the defective material or part. If Inogen replaces any product or defective material, the warranty does not extend beyond the original warranty period.

This warranty is the exclusive warranty for the products. Inogen excludes all implied conditions and warranties, except any implied condition or warranty, the exclusion of which would contravene any law or cause any part of this warranty to be void. To the fullest extent permitted by law, Inogen disclaims all liability for special, incidental, indirect, or consequential damages (including but not limited to, loss of profits) arising out of the sale or use of this product.